

PLAN VIEW OF SLOPE
(for sediment and slope control)

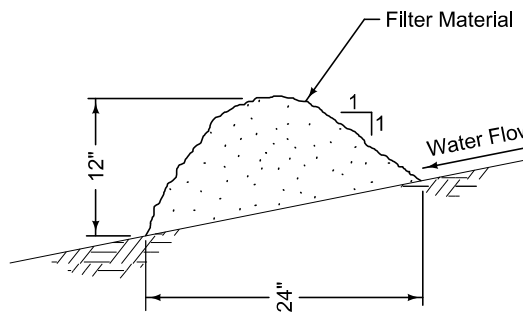

FILTER BERM

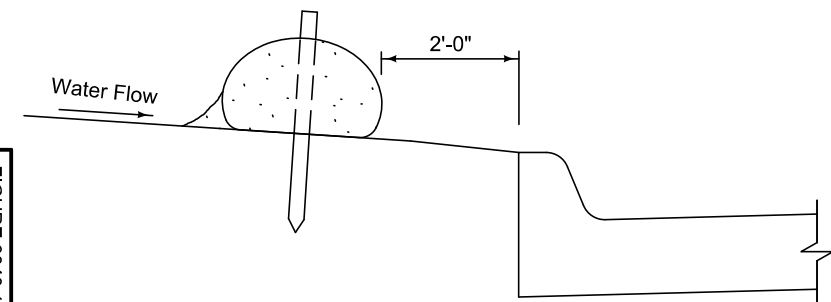

SECTION VIEW AT STREET
(for perimeter control along street)

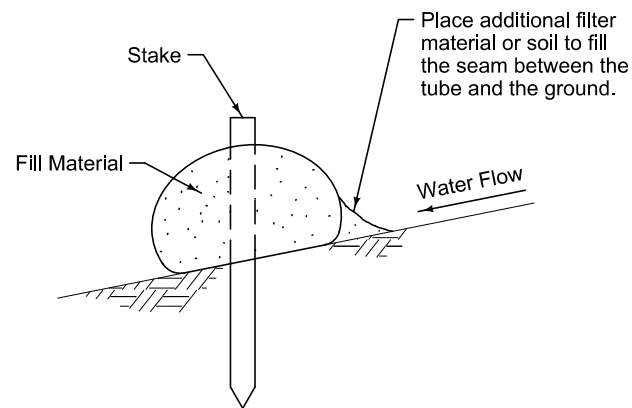

FILTER SOCK

Berm shown is typical for slopes flatter than 3:1. For steeper slopes, increase berm size as directed by the Engineer.

Place berm in uncompacted windrow perpendicular to the slope at locations specified in the contract documents.

Filter sock diameter as specified in the contract documents.

FIGURE 9040.102 SHEET 1 OF 1

TYPICAL PLACEMENT OF BERM OR SOCK

	REVISION
	3 10-18-16
	9040.102
SHEET 1 of 1	

SUDAS Standard Specifications

FILTER BERM AND FILTER SOCK