

- ① See dowel assemblies for fabrication details.
- ② See Bar Size Table.
- ③ Locate 'DW' joint at a mid-panel location between future 'C' or 'CD' joints. Place no closer than 5 feet to a 'C' or 'CD' joint.
- ④ Place bars within the limits shown under dowel assemblies.
- ⑤ Edge with 1/4 inch tool for length of joint indicated if formed; edging not required when cut with diamond blade saw. Remove header block and board when second slab is placed.
- ⑥ Unless otherwise specified, use 'CD' transverse contraction joints in mainline pavement when  $T$  is greater or equal to 8 inches. Use 'C' joints when  $T$  is less than 8 inches.
- ⑦ 'RT' joint may be used in lieu of 'DW' joint at the end of the days work. Remove any pavement damaged due to the drilling at no additional cost to the Contracting Authority.

**TRANSVERSE CONTRACTION**

		REVISION
		1 04-17-12
FIGURE 7010.101	STANDARD ROAD PLAN	<b>PV-101</b> SHEET 1 of 8
REVISIONS: Added new note 28, Added placement limits drawings on sheet 8.		
SUDAS DIRECTOR		DESIGN METHODS ENGINEER
<b>JOINTS</b>		

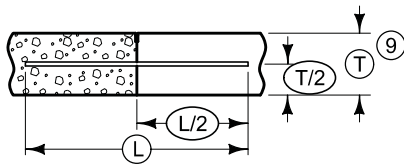

**BAR PLACEMENT**

(Applies to all joints unless otherwise detailed.)

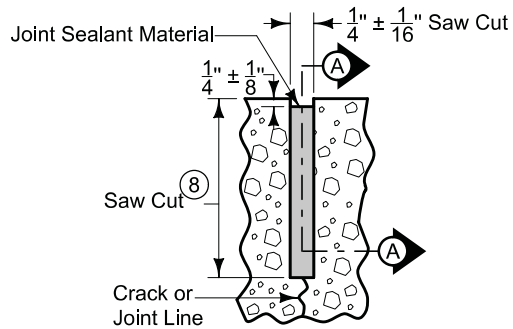

**DETAIL A**

(Saw cut formed by conventional concrete sawing equipment.)

- ⑧ Saw 'CD' joint to a depth of  $T/3 \pm 1/4"$ ; saw 'C' joint to a depth of  $T/4 \pm 1/4"$ .
- ⑨ When tying into old pavement,  $\textcircled{T}$  represents the depth of sound PCC.

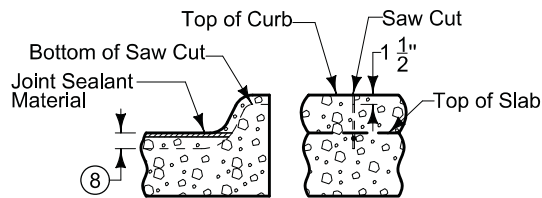

**'C' JOINT IN CURB**

(Match 'CT', 'CD', or 'C' joint in pavement.)

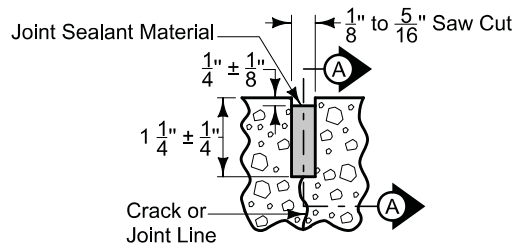

**DETAIL B**

(Saw cut formed by approved early concrete sawing equipment.)

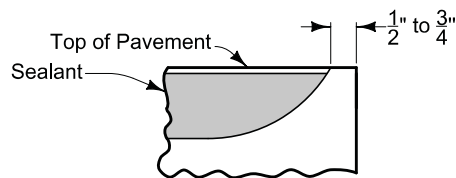

**SECTION A-A**

(Detail at Edge of Pavement)

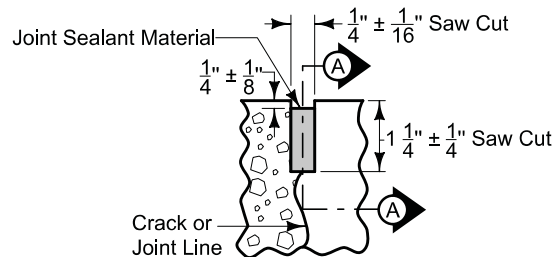

**DETAIL C**

BAR SIZE TABLE		
$\textcircled{T}$	Dowel Diameter	Tie Bar Size
< 8"	$\frac{3}{4}$ "	#6
$\geq 8"$ but < 10"	$1 \frac{1}{4}$ "	#10
$\geq 10"$	$1 \frac{1}{2}$ "	#11

**TRANSVERSE CONTRACTION**

FIGURE 7010.101 SHEET 2 OF 8

		REVISION
		1 04-17-12
FIGURE 7010.101	STANDARD ROAD PLAN	<b>PV-101</b>
		SHEET 2 of 8
<small>REVISIONS: Added new note 26, Added placement limits drawings on sheet 8.</small>		
<small>SUDAS DIRECTOR</small>		<small>DESIGN METHODS ENGINEER</small>
<p><b>JOINTS</b></p>		

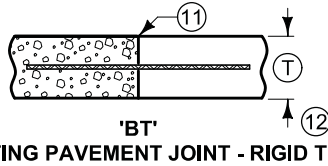
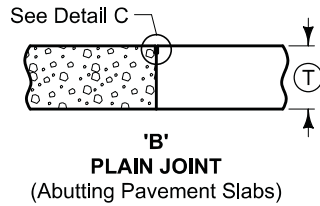

Ⓣ	Joint	Bars	Bar Length and Spacing
< 8"	'BT-1'	#4	36" Long at 30" Centers
≥ 8"	'BT-2'	#5	36" Long at 30" Centers

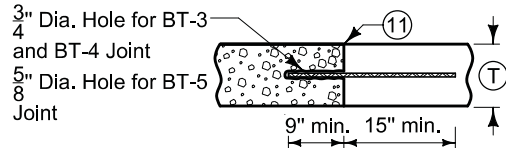

Ⓣ	Joint	Bars	Bar Length and Spacing
< 8"	'BT-5'	#4	24" Long at 30" Centers
≥ 8"	'BT-3'	#5	24" Long at 30" Centers
	'BT-4'		24" Long at 15" Centers

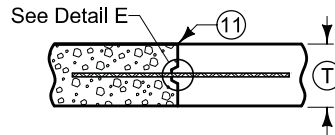
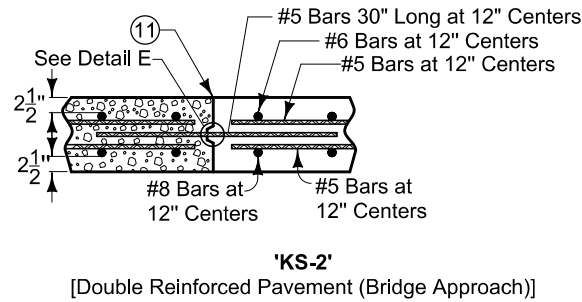
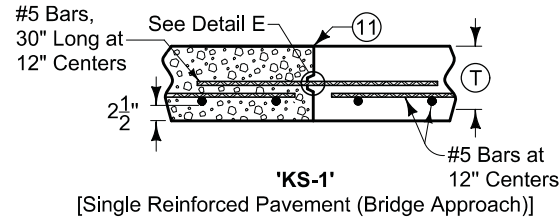
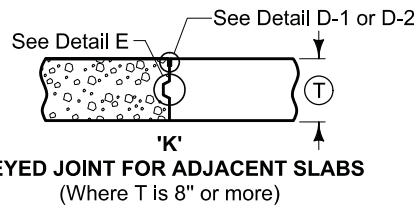

Ⓣ	Joint	Bars	Bar Length and Spacing
< 8"	'KT-1'	#4	30" Long at 30" Centers
≥ 8"	'KT-2'	#5	30" Long at 30" Centers
	'KT-3'		30" Long at 15" Centers

**LONGITUDINAL CONTRACTION**

- ⑩ Bar supports may be necessary for fixed form paving to ensure the bar remains in a horizontal position in the plastic concrete.
- ⑪ Sawing or sealing of joint not required.
- ⑫ The following joints are interchangeable, subject to the pouring sequence:  
'BT-1', 'L-1', and 'KT-1'  
'KT-2' and 'L-2'  
'KT-3' and 'L-3'

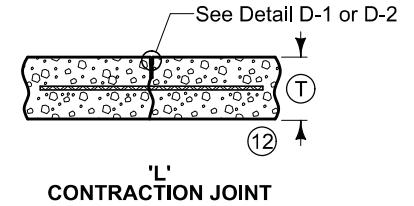

Ⓣ	Joint	Bars	Bar Length and Spacing
< 8"	'L-1'	#4	36" Long at 30" Centers
≥ 8"	'L-2'	#5	36" Long at 30" Centers
	'L-3'		36" Long at 15" Centers

SUDAS	Iowa Department of Transportation	REVISION
		1   04-17-12
FIGURE 7010.101	STANDARD ROAD PLAN	<b>PV-101</b>
		SHEET 3 of 8
REVISIONS: Added new note 26. Added placement limits drawings on sheet 8.		
Paul D. Wiegand SUDAS DIRECTOR		Deanna Marple DESIGN METHODS ENGINEER
JOINTS		

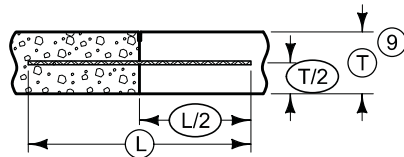

**TIE BAR PLACEMENT**  
(Applies to all joints unless otherwise detailed.)

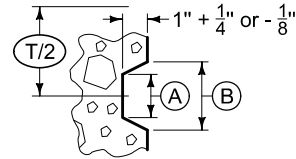

**DETAIL E**

KEYWAY DIMENSIONS			
Keyway Type	Pavement Thickness (T)	(A)	(B)
Standard	8" or greater	1 3/4"	2 3/4"
Narrow	Less than 8"	1"	2"

- ⑨ When tying into old pavement, (T) represents the depth of sound PCC.
- ⑬ Sealant or cleaning not required.

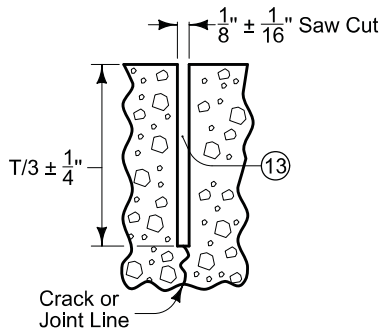

**DETAIL D-1**  
(Required when the Department of Transportation is the Contracting Authority, or when specified in the contract documents.)

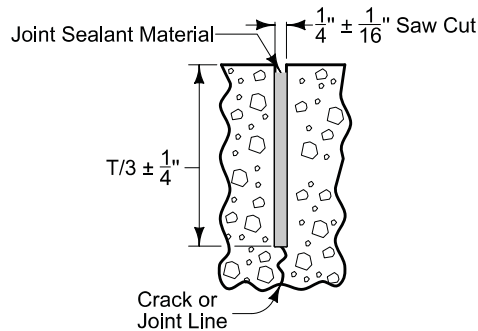

**DETAIL D-2**  
(Required when the Department of Transportation is not the Contracting Authority, or when specified in the contract documents)

**LONGITUDINAL CONTRACTION**

		REVISION
		1 04-17-12
FIGURE 7010.101	STANDARD ROAD PLAN	<b>PV-101</b>
		SHEET 4 of 8
<small>REVISIONS: Added new note 26. Added placement limits drawings on sheet 8.</small>		
<small>SUDAS DIRECTOR</small>		<small>DESIGN METHODS ENGINEER</small>
<b>JOINTS</b>		

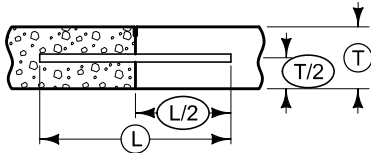

**DOWEL PLACEMENT**

(Applies to all joints unless otherwise detailed.)

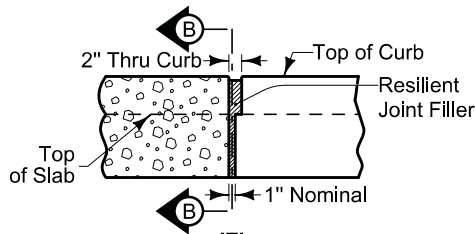

'E'

**JOINT IN CURB**  
(View at Back of Curb)

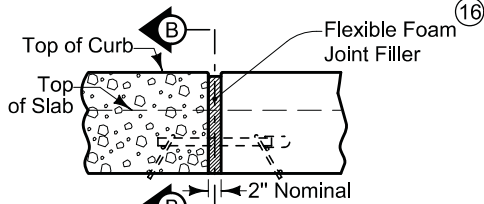

'EE'

**JOINT IN CURB**  
(View at Back of Curb)

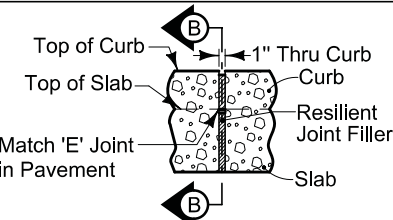

'ES'

**JOINT IN CURB**  
(View at Back of Curb)

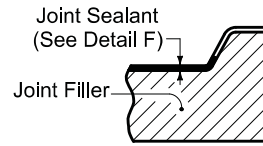

**SECTION B-B**

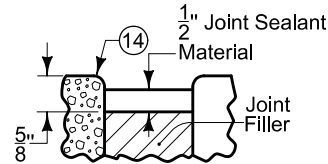

**DETAIL F**

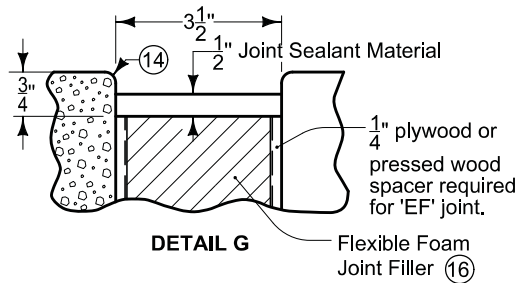

**DETAIL G**

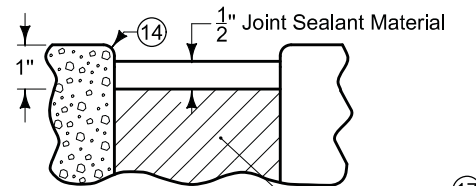

**DETAIL H**

**EXPANSION**

- ② See Bar Size Table.
- ⑭ Edge with 1/4 inch tool for length of joint indicated if formed; edging not required when cut with diamond blade saw.
- ⑮ See Dowel Assemblies for fabrication details and placement limits. Coat the free end of dowel bar to prevent bond with pavement. At intake locations, dowel bars may be cast-in-place.
- ⑯ Predrill or preform holes in joint material for appropriate dowel size.
- ⑰ Compact tire buffings by spading with a square-nose shovel.

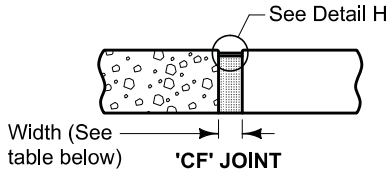

**'CF' JOINT**

TYPE	WIDTH
CF-1	2"
CF-2	2 1/2"
CF-3	3"
CF-4	3 1/2"

DOWELED EXPANSION JOINTS		
TYPE	WIDTH	FILLER MATERIAL ⑯
ED	1"	Resilient (Detail F)
EE	2"	Flexible Foam (Detail F)
EF	3 1/2"	Flexible Foam (Detail G)

BAR SIZE TABLE			
T	< 8"	≥ 8" but < 10"	≥ 10"
Dowel Diameter	3/4	1 1/4	1 1/2

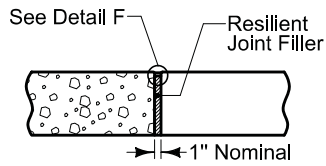

'E'

**1" EXPANSION JOINT**

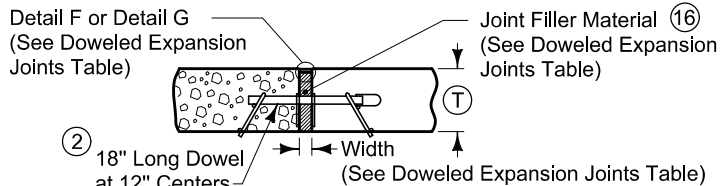

**'ED', 'EE', 'EF' ⑮**  
**DOWELED EXPANSION JOINT**

		REVISION
		1 04-17-12
FIGURE 7010.101	STANDARD ROAD PLAN	<b>PV-101</b>
SHEET 5 of 8		
REVISIONS: Added new note 26. Added placement limits drawings on sheet 8.		
<i>Paul D. Wiegand</i> SUDAS DIRECTOR <i>Deanna Markfort</i> DESIGN METHODS ENGINEER		

**JOINTS**

**CONTRACTION JOINTS**

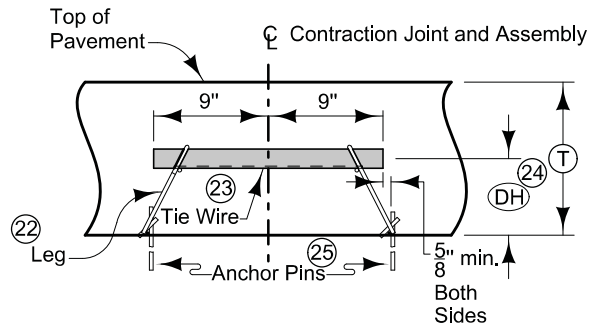
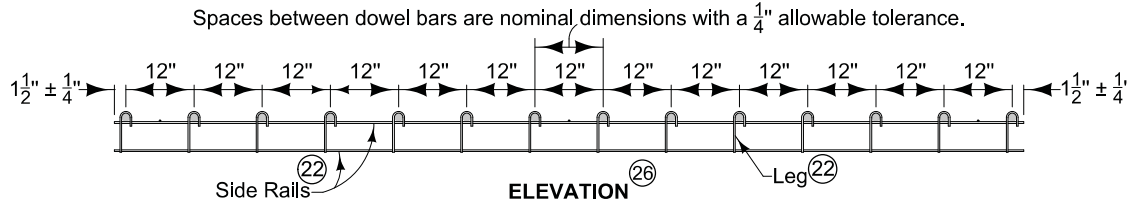
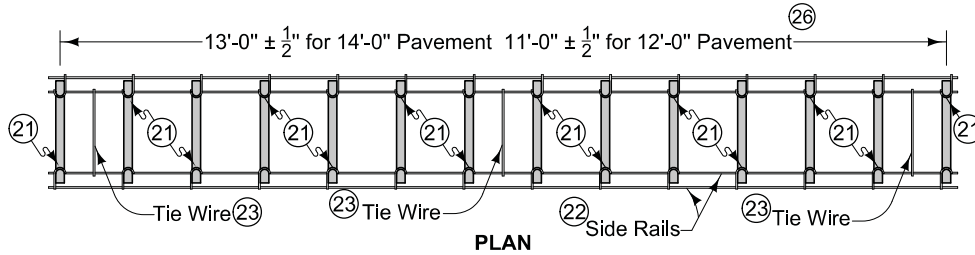

**LONGITUDINAL SECTION**

**DOWEL ASSEMBLIES**

(18)(19)(20)

DOWEL HEIGHT AND DIAMETER		
(T)	(DH) (24)	Diameter
7" to 7 $\frac{1}{2}$ "	3 $\frac{1}{2}$ "	$\frac{3}{4}$ "
8" to 9 $\frac{1}{2}$ "	4 $\frac{1}{4}$ "	1 $\frac{1}{4}$ "
10" to 11 $\frac{1}{2}$ "	5 $\frac{1}{4}$ "	1 $\frac{1}{2}$ "
12" to 13"	6 $\frac{1}{4}$ "	1 $\frac{1}{2}$ "

- (18) Use 18 inch long dowel bars with a tolerance of  $\pm 1/8$  inch. Ensure the centerlines of individual dowels are parallel to the other dowels in the assembly within  $\pm 1/8$  inch.
- (19) Wire sizes shown are the minimum required. Use wires with a minimum tensile strength of 50 ksi.
- (20) Details apply to both transverse contraction and expansion joints.
- (21) Weld alternately throughout.
- (22) #1/0 gauge (0.306 inch diameter) wire.
- (23) #10 gauge (0.135 inch diameter) wire, welded or friction fit to upper side rail, both sides.
- (24) Measured from the centerline of dowel bar to bottom of lower side rail +  $1/4$  inch.
- (25) Per lane width, install a minimum of 8 anchor pins evenly spaced (4 per side), to prevent movement of assembly during construction. Anchor assemblies placed on pavement or PCC base with devices approved by the Engineer.
- (26) If dowel basket assemblies are required for curbed pavements, the assembly length is based on the jointing layout. See PV-101, sheet 8.

		REVISION
		1 04-17-12
FIGURE 7010.101	STANDARD ROAD PLAN	<b>PV-101</b>
		SHEET 6 of 8
SUDAS DIRECTOR		DESIGN METHODS ENGINEER
JOINTS		

**EXPANSION JOINTS**

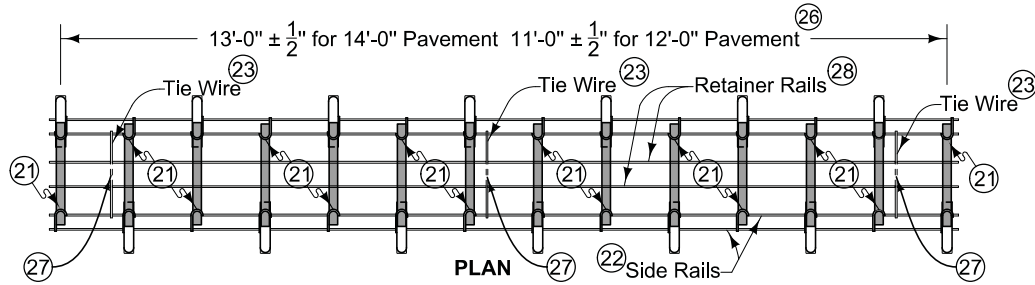

Spaces between dowel bars are nominal dimensions with a 1/4" allowable tolerance.

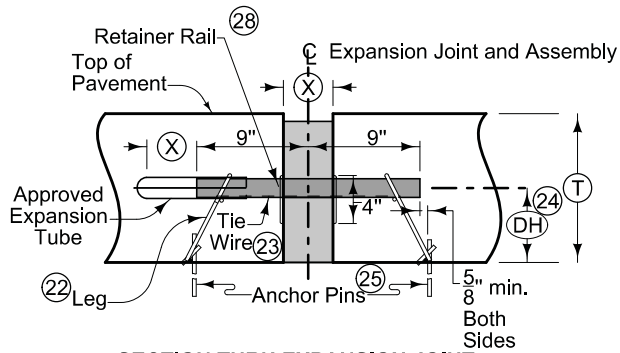
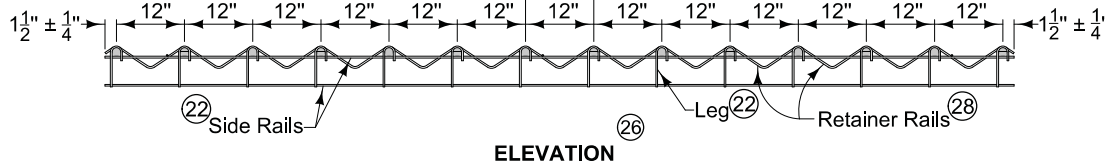

JOINT OPENING AND EXPANSION TUBE EXTENSION		
Joint Type	(X)	Minimum Tube Length
"ED"	1"	6"
"EE"	2"	7"
"EF"	3 1/2"	9"

DOWEL HEIGHT AND DIAMETER		
(T)	(DH) (24)	Diameter
7" to 7 1/2"	3 1/2"	3/4"
8" to 9 1/2"	4 1/4"	1 1/4"
10" to 11 1/2"	5 1/4"	1 1/2"
12" to 13"	6 1/4"	1 1/2"

**DOWEL ASSEMBLIES**

(18) (19) (20)

- (18) Use 18 inch long dowel bars with a tolerance of ± 1/8 inch. Ensure the centerlines of individual dowels are parallel to the other dowels in the assembly within ± 1/8 inch.
- (19) Wire sizes shown are the minimum required. Use wires with a minimum tensile strength of 50 ksi.
- (20) Details apply to both transverse contraction and expansion joints.
- (21) Weld alternately throughout.
- (22) #1/0 gauge (0.306 inch diameter) wire.
- (23) #10 gauge (0.135 inch diameter) wire, welded or friction fit to upper side rail, both sides.
- (24) Measured from the centerline of dowel bar to bottom of lower side rail + 1/4 inch.
- (25) Per lane width, install a minimum of 8 anchor pins evenly spaced (4 per side), to prevent movement of assembly during construction. Anchor assemblies placed on pavement or PCC base with devices approved by the Engineer.
- (26) If dowel basket assemblies are required for curbed pavements, the assembly length is based on the jointing layout. See PV-101, sheet 8.
- (27) Clip and remove center portion of tie during field assembly.
- (28) 1/4 inch diameter wire.

FIGURE 7010.101 SHEET 7 OF 8

SUDAS Iowa Department of Transportation	REVISION	1	04-17-12
	FIGURE 7010.101	STANDARD ROAD PLAN	PV-101 SHEET 7 of 8
REVISIONS: Added new note 26. Added placement limits drawings on sheet 8.			
Paul D. Wiegand SUDAS DIRECTOR		Deanna Marfeldt DESIGN METHODS ENGINEER	
JOINTS			

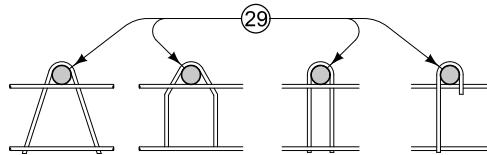

OPTIONAL LEG SHAPES

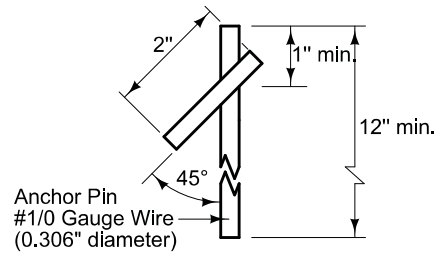

ANCHOR PIN

- ⑱ Use 18 inch long dowel bars with a tolerance of  $\pm 1/8$  inch. Ensure the centerlines of individual dowels are parallel to the other dowels in the assembly within  $\pm 1/8$  inch.
- ⑲ Wire sizes shown are the minimum required. Use wires with a minimum tensile strength of 50 ksi.
- ⑳ Details apply to both transverse contraction and expansion joints.
- ㉑ Diameter of bend around dowel is dowel diameter +  $1/8$  to  $3/16$  inches.

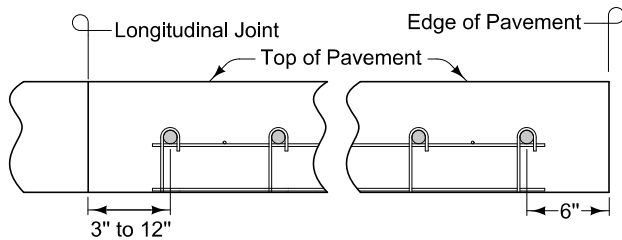

PLACEMENT LIMITS  
(Rural Section)

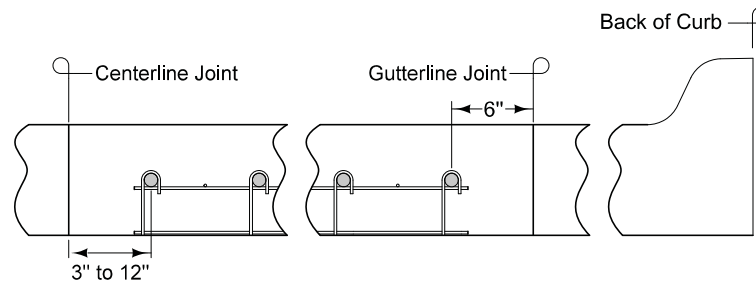

PLACEMENT LIMITS  
(Curb and Gutter - Gutterline Jointing)

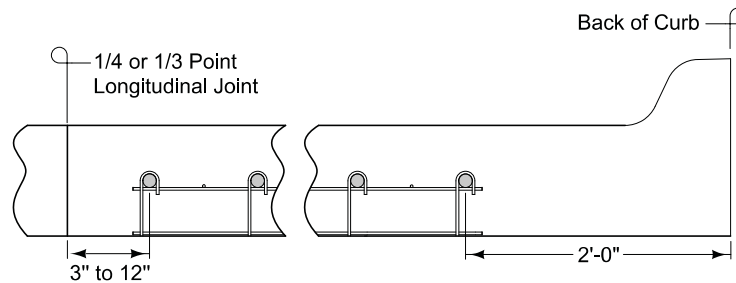

PLACEMENT LIMITS  
(Curb and Gutter - 1/4 or 1/3 Point Jointing)

**DOWEL ASSEMBLIES** ⑱⑲⑳

SUDAS Iowa Department of Transportation	REVISION
	1 04-17-12
FIGURE 7010.101	STANDARD ROAD PLAN
<b>PV-101</b>	
SHEET 8 of 8	

REVISIONS: Added new note 26, Added placement limits drawings on sheet 8.

*Paul D. Wigand* SUDAS DIRECTOR      *Deanna Maxwell* DESIGN METHODS ENGINEER

JOINTS