

Pt. 'J' to Pt. 'G'  
 $\Delta = 8^\circ 01' 17.07''$   
 $T = 140.23'$   
 $L = 280.00'$   
 $E = 4.91'$   
 $R = 2000.00'$

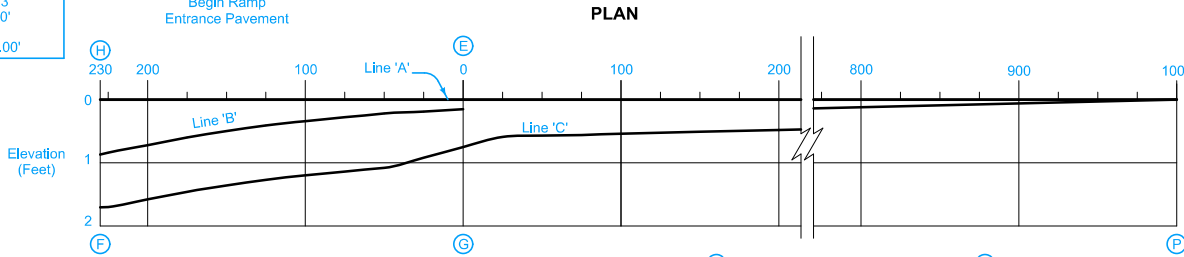

NOTE: The algebraic difference between profile grade for Ramp Base Line at (F) and relative profile grade of Mainline at (H) is 0.54%.

Construct ramp entrance pavement the same thickness as mainline pavement.

Ramp entrance pavement shown by shaded area is 1793 square yards.

For joint details, see PV-101

- ① For header construction details at the end of taper, see Typical 7101 or Typical 7102.
- ② Construct subbase for ramp entrance pavement the same thickness as mainline subbase.

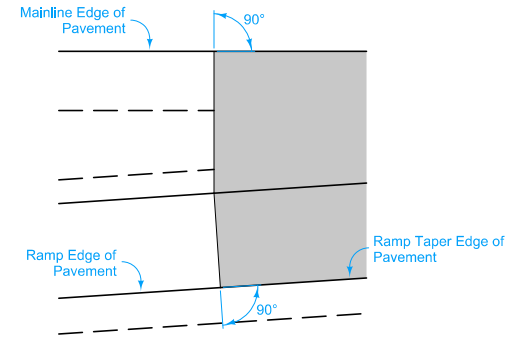

DETAIL A

		TABLE OF OFFSETS AND DROPS FOR 16' RAMP TAPER																								
Distance From Point (E) Along Line 'A' (Ft.)		230	225	200	175	150	125	100	75	50	25	0	25	50	75	100	200	300	400	500	600	700	800	900	1000	
From Line 'A' To Line 'B'	Offset (Ft.)	21.76	21.10	17.95	15.11	12.59	10.38	8.48	6.90	5.62	4.66	4.0														
	Slope (%)	Constant 4.0% Slope												3.78												
	Drop (Ft.)	0.87	0.84	0.72	0.60	0.50	0.42	0.34	0.28	0.22	0.19	0.15														
From Line 'B' To Line 'C'	Offset (Ft.)	Constant 16.0' Offset																								
	Slope (%)	5.40	5.40	5.40	5.40	5.40	5.40	5.40	5.40	5.40	4.58	3.78														
	Drop (Ft.)	0.86	0.86	0.86	0.86	0.86	0.86	0.86	0.86	0.86	0.73	0.60														
From Line 'A' To Line 'C'	Offset (Ft.)												19.5	19.0	18.5	18.0	16.0	14.0	12.0	10.0	8.0	6.0	4.0	2.0	0.0	
	Slope (%)													Constant 3.0% Slope												
	Drop (Ft.)	1.73	1.70	1.58	1.46	1.36	1.28	1.20	1.14	1.08	0.92	0.75	0.59	0.57	0.56	0.54	0.48	0.42	0.36	0.30	0.24	0.18	0.12	0.06	0.0	
Distance From Point (G) Along Line 'C' (Ft.)		228.66	223.66	198.66	173.70	148.77	123.87	99.00	74.15	49.31	24.49	0.00														

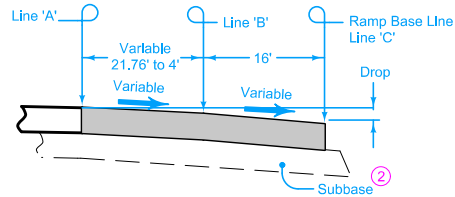

SECTION A-A

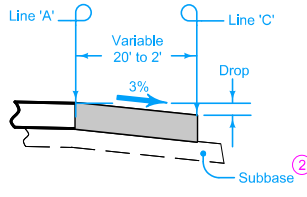

SECTION B-B

TABLE OF SHOULDER TRANSITION LENGTHS			
W <sub>1</sub>	Shoulder Width beyond Edge of Mainline Pavement		
	8'	10'	12'
12'	NA	200'	300'

NOTE: W<sub>1</sub> is the width of the outside lane to the Edge of Pavement.

**STANDARD ROAD PLAN**

REVISIONS: Removed INTERIM from the standard and modified leader line for circle note 9.

*Handwritten Signature*  
APPROVED BY DESIGN METHODS ENGINEER

REVISION  
6 04-21-20

**PV-411**

SHEET 1 of 2

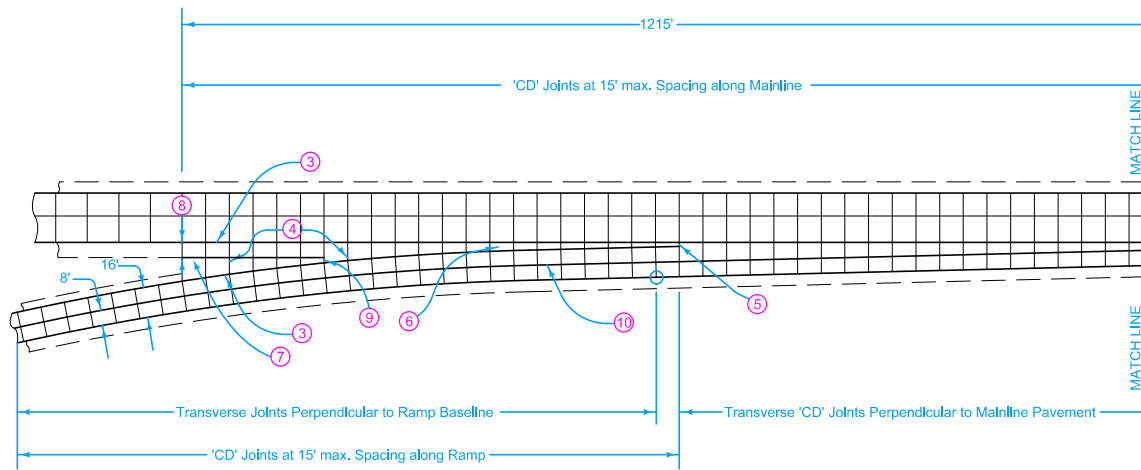

**ACCELERATION TAPER  
FOR 16' ENTRANCE RAMP**

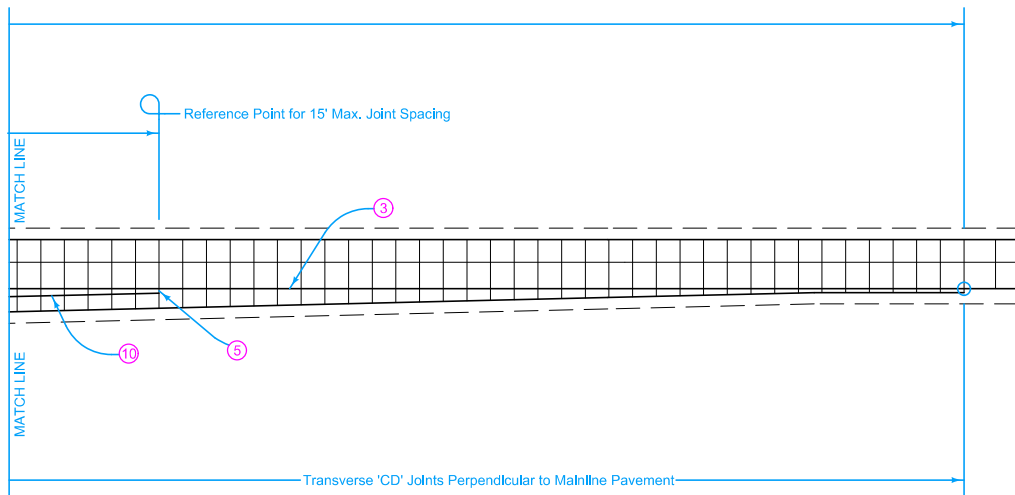

- ③ 'BT-2' or 'KT-2' Joint.
- ④ 'C' Joint.
- ⑤ 'B' Joint. 2' minimum, 4' maximum.
- ⑥ Construct transverse joints on the entrance ramp taper perpendicular to the tapered edge where the gore area is greater than 4 feet.
- ⑦ 'C' Joint equal to mainline shoulder width.
- ⑧ 10' minimum, or equal to mainline shoulder width.
- ⑨ 'B' or 'C' Joint. 2' minimum. 4' maximum.
- ⑩ 'L-2' Joint.



16' ENTRANCE RAMP

 <b>STANDARD ROAD PLAN</b>	REVISION 6   04-21-20
	<b>PV-411</b> SHEET 2 of 2
<small>REVISIONS: Removed INTERIM from the standard and modified leader line for circle note 9.</small>	
 <small>APPROVED BY DESIGN METHODS ENGINEER</small>	
<b>ACCELERATION TAPER FOR 16' ENTRANCE RAMP</b>	