

TYPICAL PLAN FOR FILLET AT ENTRANCE OR INTERSECTING ROAD

For temporary runouts and wedges, place subgrade paper, burlap, or similar material over adjacent surfaces to facilitate removal. Construct temporary runout at a length of 10 feet for each 1 inch of resurfacing thickness.

Construct wedge shaped asphalt fillets at all paved entrances and paved roads. Construct full thickness fillets at all non-paved entrances and non-paved roads.

- ① Width of fillet is 4 feet for each inch of overlay thickness.
- ② The runout length of the intermediate course is equal to the total runout length, multiplied by the intermediate course thickness, divided by the total resurfacing thickness.
- ③ Excavate and shape road or entrance as required to accommodate proposed fillet.
- ④ For existing fillets at non-paved roads and entrances, construct a wedge shaped fillet matching the thickness of the resurfacing.
- ⑤ Match width and shape of existing pavement.

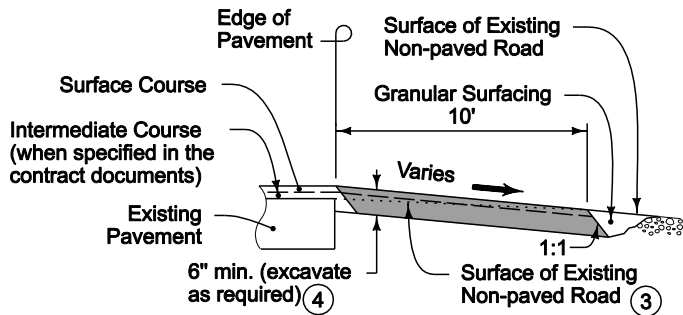

SECTION A-A  
(Full Thickness Fillet - Non-paved Road)

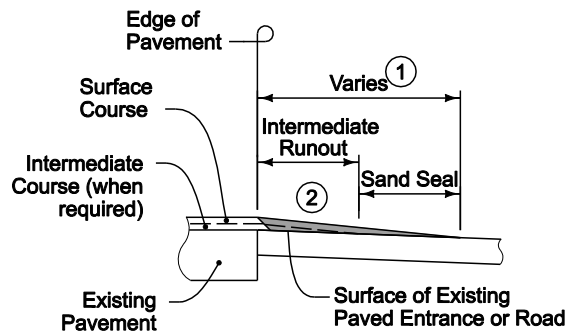

SECTION A-A  
(Wedge Shaped Fillet - Paved Entrance or Road)

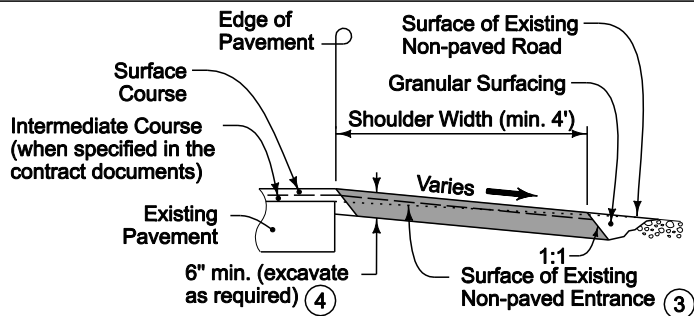

SECTION A-A  
(Full Thickness Fillet - Non-paved Entrance)

MINIMUM FILLET WIDTH		
TYPE OF ACCESS	PRIMARY ROADS	SECONDARY AND LOCAL ROADS
	(F) ft.	(F) ft.
Residential Entrance	40	12
Farm Entrance	60	18
Commercial Entrance	80	24
Non-paved Road	100	30
Paved Road	Variable ⑤	Variable ⑤

RUNOUT LENGTH	
POSTED SPEED LIMIT (mph)	RUNOUT RATIO (ft. per inch)
45 or More	50
20 to 45	25

GENERAL DETAILS

FIGURE 7020.903 SHEET 1 OF 3

	REVISION New 10-19-10	
	SUDAS <b>7020.903</b>	
	SHEET 1 of 3	
SUDAS Standard Specifications		
DETAILS FOR ASPHALT RESURFACING		

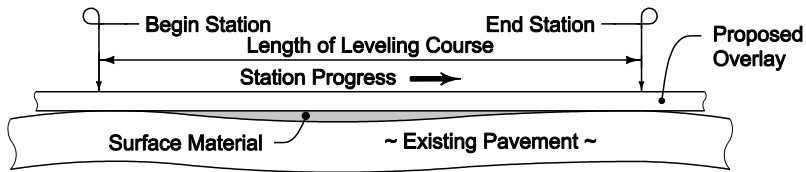

**TYPICAL LEVELING COURSE**

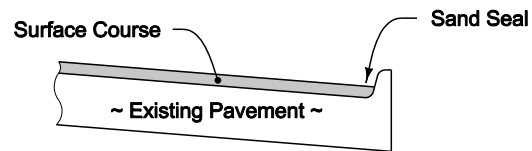

**GUTTERLINE EDGE - MATCH**

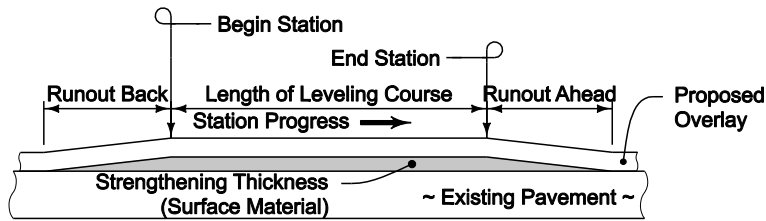

**TYPICAL STRENGTHENING COURSE**

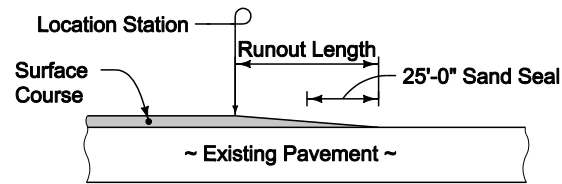

**WEDGE SHAPED RUNOUT  
(When Milling is not Specified)**

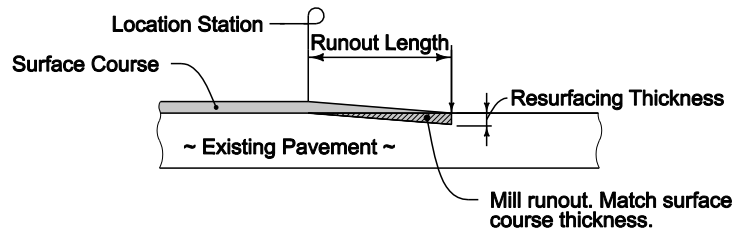

**MILLED SURFACE NOTCH FOR RUNOUT**

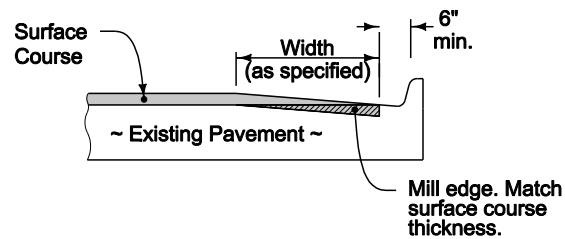

**GUTTERLINE EDGE - NOTCH**

**SINGLE COURSE RESURFACING**

FIGURE 7020.903 SHEET 2 OF 3

	REVISION
	New 10-19-10
	<b>7020.903</b>
SHEET 2 of 3	

SUDAS Standard Specifications

DETAILS FOR ASPHALT RESURFACING

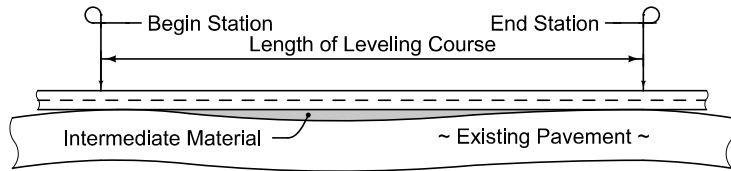

**TYPICAL LEVELING COURSE**

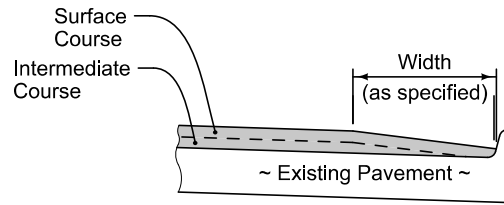

**GUTTERLINE EDGE - MATCH**

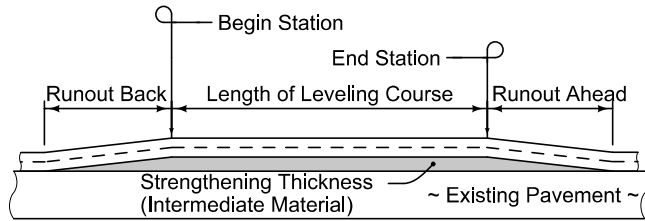

**TYPICAL STRENGTHENING COURSE**

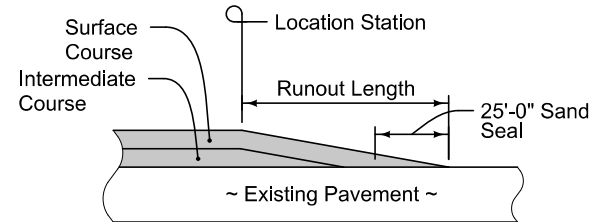

**WEDGE SHAPED RUNOUT**  
(When Milling is not Specified)

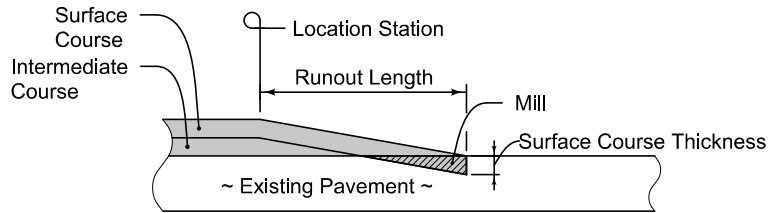

**MILLED SURFACE NOTCH RUNOUT**

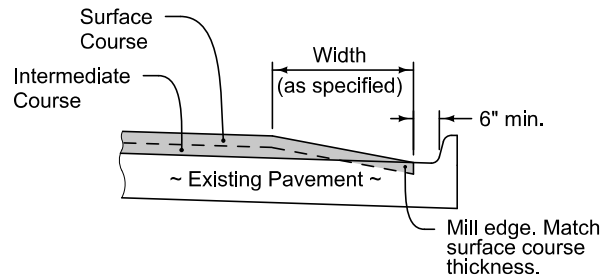

**GUTTERLINE EDGE - NOTCH**

FIGURE 7020.903 SHEET 3 OF 3

**DOUBLE COURSE RESURFACING**

	<b>SUDAS</b>		REVISION
	New	10-19-10	<b>7020.903</b>
			SHEET 3 of 3

SUDAS Standard Specifications

DETAILS FOR  
ASPHALT RESURFACING